

ZAXIS-6 series

HITACHI

Reliable solutions

ZAXIS170W



HYDRAULIC EXCAVATOR

Model code : ZX170W-6

Engine rated power : 128.4 kW (ISO14396)

Operating weight : 17 300 – 19 100 kg

Bucket ISO heaped : 0.52 – 0.82 m³

ZX170W-6. NO COMPROMISE

The ZX170W-6 is easy to operate and manoeuvre around a variety of job sites, and exceptionally versatile for different applications. It incorporates unique industry-leading Hitachi technology, but without compromising on its user-friendly appeal.

Hitachi wheeled excavators share the same high-quality engineering, reliability and durability as its crawler models. With excellent stability, powerful travel and swing forces, and impressive lifting capacity, the ZX170W-6 is the ultimate universal working machine.



6. PROVEN RELIABILITY



8. OUTSTANDING DURABILITY



10. EXTRAORDINARY VERSATILITY



12. QUALITY ASSURED



14. PIONEERING TECHNOLOGY

DEMAND PERFECTION

Following feedback from European customers, Hitachi engineers in Japan have developed the ZX170W-6 to perfection with more than 100 design updates.

Every single improvement contributes to Hitachi's overall aim of lowering the total cost of ownership. Collectively, they help to provide greater durability, better performance and increased operational efficiency.



High quality

Only the best design elements and materials.



Incredible versatility

Tilt and rotary tilt modes complete the attachment support system.



Lifetime reliability

Reliable components help to prevent oil leaks.



Ultimate durability

Solid and reliable undercarriage, modular in design.





Optimum performance

Remote monitoring with Global e-Service online application.



User-friendly

Easily accessible cab with step and wide entry.



Low emissions

SCR system reduces exhaust gas emissions.



Excellent efficiency

HIOS IV system reduces total hydraulic loss.



Easy maintenance

Convenient and wide-opening engine cover.



Low fuel consumption

10% fuel saving in PWR mode (9% in ECO mode).



“ *Our maintenance costs are lower and there is minimal downtime* ”

Matthias Schindler, Director, Joh. Sahler GmbH

PROVEN RELIABILITY

Hitachi is renowned for manufacturing reliable construction machinery. Its Zaxis-6 wheeled excavator range has been designed to achieve optimum levels of performance and availability, and operate efficiently all day, every day, with minimal downtime.

Easy maintenance

The lightweight split-type engine hood opens widely for convenience. It provides easy access to the engine compartment and after-treatment device for routine maintenance.

User-friendly fuel filter

The main fuel filter screws into place on the ZX170W-6. This makes it easier to replace and ensures that dust is prevented from entering the fuel circuit during routine maintenance procedures.

More efficient cooling

The expansion tank is mounted on top of the engine's cooling system. This revised position means that the air can be completely removed and prevents the engine parts from overheating.

Durable hydraulic connection

A rubber hose fitted with a flange has been incorporated into the design of the hydraulic return pipes. These enhance the reliability of the system and reduce the risk of oil leaks.



Easy access to the engine compartment.



The main fuel filter is easier to replace.



The expansion tank prevents engine parts from overheating.



HITACHI

HITACHI

ZA/IS
170W



High ground clearance reduces damage from obstacles.



Large blade cylinder cover offers greater protection.



i Hitachi excavators are tested extensively in job site conditions on Hokkaido, the second largest and northernmost Japanese island, in temperatures ranging from -25°C to 35°C.



OUTSTANDING DURABILITY

The durability of the ZX170W-6 ensures it can achieve high levels of availability and operates reliably every time, even in challenging conditions. It has been designed with robust features and components, including a durable undercarriage and class-leading exhaust equipment.



Reinforced for safer working environment.

Oil leak prevention

The O-rings on the swing motor are made from fluorine. This highly durable material withstands high oil temperatures and reinforces the parts' reliability to prevent oil leaks.

Enhanced fuel circuit

A high-performance water separator and cold fuel resistance valve are integrated into the pre-filter for added protection against moisture. In addition, a large capacity electric fuel pump supplies an appropriate amount of fuel to the engine for improved performance.

Engine protection

The combustion chamber is made from

stronger materials and the revised shape of the piston is designed to achieve cleaner emissions. These features will further enhance the reliability of the engine.

Greater protection

The blade cylinder cover is larger on the ZX170W-6 than the previous model. The outrigger's cylinder cover has also been reinforced. This enhances the reliability of both components.

High ground clearance

The transmission unit is installed over the axle to reduce damage caused by hitting unexpected obstacles.



“ *It is the perfect solution and does everything that I need it to do* ”

Marco Volland, operator, Forst- und Baggerbetrieb Horn

EXTRAORDINARY VERSATILITY

Versatility is vital for users of wheeled excavators. The ZX170W-6 is easy to operate and manoeuvre, both on- and off-road, and is suitable for various applications with different attachments. Its modular undercarriage design also offers flexibility – outriggers can be positioned at the front or rear, or in combination with a blade, for excellent stability.

Greater flexibility

The rotary tilt and tilt modes are included within the attachment support system on the ZX170W-6. These and nine other modes can be registered on the monitor for the easy fitment of attachments to increase versatility.

Power boost

The tried-and-tested power-boost feature has 10% more capacity than the ZX170W-3. This increases the capability of the ZX170W-6 to deliver an enhanced level of excavating performance and lifting power.

Reduced maintenance

The counterweight has been redesigned and features LEDs in the tail lights. These not only provide better visibility in poor light, but also require less maintenance, which helps to reduce costs.

Excellent visibility

The cab of the Zaxis-6 wheeled excavator offers excellent visibility. It features a small steering column and a monitor positioned within the right pillar, so not to obscure the operator's view of the job site.



Two tilt modes add to the versatility of the ZX170W-6.



Power boost has 10% more capacity.



LED tail lights are easily maintained.



Superior weather resistance maintains the cab's internal appearance.



Urea is injected into the exhaust gas to reduce emissions.



i There are up to 100 points on the Hitachi Design Centre's checklist to measure the quality of its construction machinery, covering performance, reliability and safety.



QUALITY ASSURED

The high-quality design and engineering of the ZX170W-6 is integral to its performance on the job site and user experience. Before delivery, it is rigorously checked for the highest possible standards of safety and reliability, providing peace of mind for owners and operators.



Ergonomic controls contribute to the ultimate workspace.

Superior cooling performance

The upper structure benefits from high-quality sealant (around the cooling package) and acoustic materials to eliminate any deterioration caused by heat. These ensure the long-term cooling and low-noise acoustic performance of the ZX170W-6.

Excellent weather resistance

The in cab console has been sculpted in highly durable AES-grade resin. This ensures superior weather resistance and ultimately prevents the sun's ultraviolet rays from damaging the console.

Reduced emissions

Hitachi has developed a selective catalytic reduction (SCR) system that injects urea into exhaust gas to reduce nitrogen

oxide from emissions. This cutting-edge technology not only helps the environment, but also complies with EU Stage IV emission regulations.

Ultimate comfort

A fully adjustable seat, spacious cab, ergonomic controls and advanced music system all contribute to the ultimate working environment.

Safety at work

The ZX170W-6 has been fitted with a high-spec rollover protective structure-compliant (ROPS) and centre pillar reinforced structure (CRES V) cab. The pressurised cab is designed to protect the operator from the penetration of dust and potential job site risks.



“ *Our European customers helped us to develop the Zaxis-6 wheeled excavator* ”

Burkhard Janssen, General Manager Product Management & Engineering, Hitachi Construction Machinery (Europe) NV

PIONEERING TECHNOLOGY

The innovative ZX170W-6 incorporates several technological features designed to enhance efficiency, improve performance and reduce the total cost of ownership. It epitomises Hitachi’s advanced technological approach to meet the needs of the European construction industry with its reliable solutions.

Saving fuel and costs

Hydraulic loss is decreased by HIOS IV technology. It reduces the hydraulic oil returned to the tank due to the cooperative control of the pump and valve. This helps to lower fuel consumption by 10% in PWR mode with the same productivity.

User-friendly functionality

A large seven-inch multi-function LCD monitor provides a wide range of useful technical information. With multi-lingual support in up to 32 languages, it enables operators to check the machine’s status and settings at a glance.

Remote monitoring

Global e-Service allows owners to monitor their fleets remotely via Owner’s Site (24/7 online access) and ConSite (an automatic monthly report). These help to maximise efficiency, minimise downtime and improve overall performance.

Fewer emissions

The after-treatment device consists of a diesel oxidation catalyst (DOC), urea mixing pipe, SCR system and silencer. This advanced technology helps to reduce emissions and noise levels.

Advanced audio system

The AM/FM radio is accessible from the monitor and an auxiliary socket – for devices such as MP3 players – is linked to the sound system. This choice of entertainment helps to provide an enjoyable – and productive – working environment.



10% lower fuel consumption in PWR mode with HIOS IV.



The LCD monitor shows the machine's status and settings.



The SCR system reduces emissions and noise levels.



“ *The total cost of ownership is of maximum benefit to our company* ”

Peter Kögel, Member of the Management Board,
Kögel Bau GmbH & Co. KG

REDUCING THE TOTAL COST OF OWNERSHIP



Hitachi has created the Support Chain after-sales programme to ensure optimum efficiency, as well as minimal downtime, reduced running costs and high resale values.

Global e-Service

Hitachi has developed two remote monitoring systems as part of its Global e-Service online application. Owner's Site and ConSite are an integral part of the excavator, which sends operational data daily via GPRS or satellite to www.globaleservice.com. This allows immediate access to the Owner's Site, and the vital information that is required for support on job sites.

Comparing the ratio of operating and non-operating hours helps to enhance efficiency. Effective management of maintenance programmes helps to

maximise availability. Running costs can also be managed by analysing the fuel consumption. The location and movements of each machine are clearly displayed for essential planning.

An automatic service report – ConSite – sends a monthly email summarising the information from Global e-Service for each machine. This includes: daily working hours and fuel consumption data; statistics on the operating mode ratio, plus a comparison for fuel consumption/efficiency, and CO₂ emissions.

Technical support

Each Hitachi service technician receives full technical training from HCME in Amsterdam. These sessions provide access to the same technical knowledge available within the Hitachi quality assurance departments and design centres. Technicians combine this global expertise with the local language and culture of the customer to provide the highest level of after-sales support.

Extended warranty and service contracts

Every new Hitachi Zaxis-6 model is covered by a full manufacturer's warranty. For



Global e-Service



Technical support



Hitachi Parts

extra protection – due to severe working conditions or to minimise equipment repair costs – Hitachi dealers offer a unique extended warranty called HELP (Hitachi Extended Life Program) and comprehensive service contracts. These can help to optimise the performance of each machine, reduce downtime and ensure higher resale values.

Parts

Hitachi offers a wide range and a high availability of parts dispatched from the

53,000 m² HCME European Parts Depot in The Netherlands.

- Hitachi Genuine Parts: allow machines to work for longer, with lower running and maintenance costs.
- Hitachi Select Parts and 2Genuine Parts: especially for older machines, they cost less, are of proven quality and come with the manufacturer's warranty.

- Performance Parts: to cope with highly demanding conditions, they have been engineered for greater durability, better performance or longer life.
- Remanufactured components: offering an economically viable solution, they are the best option when preventative replacements are required.

Whatever the choice, the renowned quality of Hitachi construction machinery is assured.



EH dump trucks



EX ultra-large excavators



ZW wheel loaders



“ We develop construction machinery that contributes to the creation of affluent and comfortable societies ”

Yuichi Tsujimoto, HCM President

BUILDING A BETTER FUTURE

Established in 1910, Hitachi, Ltd. was built upon a founding philosophy of making a positive contribution to society through technology. This is still the inspiration behind the Hitachi group's reliable solutions that answer today's challenges and help to create a better world.

Hitachi, Ltd. is now one of the world's largest corporations, with a vast range of innovative products and services. These have been created to challenge convention, improve social infrastructure and contribute to a sustainable society.

Hitachi Construction Machinery Co., Ltd. (HCM) was founded in 1970 as a subsidiary of Hitachi, Ltd. and has become one of the world's largest construction equipment suppliers. A pioneer in producing hydraulic excavators, HCM also manufactures wheel loaders, rigid dump trucks, crawler cranes and special application machines at state-of-the-art facilities across the globe.

Incorporating advanced technology, Hitachi construction machinery has a reputation for the highest quality standards. Suitable for a wide range of industries, it is always

hard at work around the world – helping to create infrastructure for a safe and comfortable way of living, developing natural resources and supporting disaster relief efforts.

Hitachi Zaxis excavators are renowned for being reliable, durable and versatile – capable of delivering the highest levels of productivity under the most challenging of conditions. They are designed to provide owners with a reduced total cost of ownership, and operators with the ultimate level of comfort and safety.



Mini excavators

SPECIFICATIONS

ENGINE

Model	Isuzu AR-4HK1X
Type	4-cycle water-cooled, common rail direct injection
Aspiration	Variable geometry turbocharged, intercooled, cooled EGR
Aftertreatment	DOC and SCR system
No. of cylinders	4
Rated power	
ISO 14396	128.4 kW at 2 000 min ⁻¹
ISO 9249, nett	122 kW at 2 000 min ⁻¹
SAE J1349, net	122 kW at 2 000 min ⁻¹
Maximum torque	670 Nm at 1 600 min ⁻¹
Piston displacement	5.193 L
Bore and stroke	115 mm x 125 mm
Batteries	2 x 12 V / 93 Ah

HYDRAULIC SYSTEM

Hydraulic Pumps

Main pumps	2 variable displacement axial piston pumps
Maximum oil flow	2 x 157 L/min
Pilot pump	1 gear pump
Maximum oil flow	30 L/min
Steering pump	1 gear pump
Maximum oil flow	28.6 L / min

Hydraulic Motors

Travel	1 variable displacement axial piston motor
Swing	1 axial piston motor

Relief Valve Settings

Implement circuit	34.3 MPa
Swing circuit	33.4 MPa
Travel circuit	34.8 MPa
Pilot circuit	3.9 MPa
Power boost	36.3 MPa

Hydraulic Cylinders

	Quantity	Bore	Rod diameter
Boom	2	110 mm	80 mm
Arm	1	120 mm	90 mm
Bucket	1	105 mm	75 mm
Positioning *	1	170 mm	105 mm

* : For 2-piece boom

UPPERSTRUCTURE

Revolving Frame

D-section frame for resistance to deformation.

Swing Device

Axial piston motor with planetary reduction gear is bathed in oil. Swing circle is single-row. Swing parking brake is spring-set/hydraulic-released disc type.

Swing speed	12.2 min ⁻¹
Swing torque	42.8 kNm

Operator's Cab

Independent spacious cab, 1 005 mm wide by 1 675 mm high, conforming to ISO* Standards.

* International Organization for Standardization

UNDERCARRIAGE

Wheeled type undercarriage. The frame is of welded, stress-relieved structure.

Drive system: 2 speed power shift transmission and variable displacement axial piston type travel motor.

Travel speed (forward and reverse)

Creeper speed range	0 to 2.4 km / h
Low speed range	0 to 8.6 km / h
High speed range	0 to 35 km / h

Maximum traction force	102 kN
Gradeability	70% (35 degree)
Min. turning radius.....	6 650 mm

Axle:

All-wheel drive.

The front axle can be locked hydraulically in any position.

Oscillating front axle..... ± 7°

Brakes system:

Maintenance free wet-disc brakes on axle are standard.

Fully hydraulic service brake system

SOUND LEVEL

Sound level in cab according to ISO 6396 LpA 72 dB(A)

External sound level according to ISO 6395 and

EU Directive 2000/14/EC LwA 100 dB(A)

SERVICE REFILL CAPACITIES

Fuel tank	290.0 L
Engine coolant	28.0 L
Engine oil	23.0 L
Swing device	6.2 L
Transmission	2.5 L
Front differential gear	9.5 L
Rear differential gear	14.0 L
Hub reduction gear	
Front axle	2 x 2.5 L
Rear axle	2 x 2.5 L
Hydraulic system	180.0 L
Hydraulic tank	100.0 L
DEF/AdBlue® tank	26.0 L

WEIGHTS

Operating Weight

Arm length	Stabilization	Monoblock	2-Piece
		Standard gauge / Wide gauge	Standard gauge / Wide gauge
		kg	kg
2.21 m	Rear Blade	–	17 800
	Rear Outrigger	–	18 100
	Outrigger and Blade	–	18 800
	Front and Rear Outrigger	–	19 100
2.22 m	Rear Blade	17 300	–
	Rear Outrigger	17 500	–
	Outrigger and Blade	18 300	–
	Front and Rear Outrigger	18 500	–
2.50 m	Rear Blade	–	17 900
	Rear Outrigger	–	18 100
	Outrigger and Blade	–	18 900
	Front and Rear Outrigger	–	19 100
2.58 m	Rear Blade	17 300	–
	Rear Outrigger	17 600	–
	Outrigger and Blade	18 300	–
	Front and Rear Outrigger	18 600	–
3.08 m	Rear Blade	17 400	–
	Rear Outrigger	17 600	–
	Outrigger and Blade	18 400	–
	Front and Rear Outrigger	18 600	–

Including 0.60 m³ (ISO heaped), bucket weight (500 kg) and counterweight (3 400 kg).

BUCKET AND ARM DIGGING FORCE

Arm length	ZAXIS 170W with monoblock boom		
	2.22 m	2.58 m	3.08 m
Bucket digging force* ISO	108 kN		
Bucket digging force* SAE : PCSA	95 kN		
Arm crowd force* ISO	110 kN	87 kN	78 kN
Arm crowd force* SAE : PCSA	106 kN	84 kN	75 kN

* At power boost

Arm length	ZAXIS 170W with 2-piece boom	
	2.21 m	2.50 m
Bucket digging force* ISO	108 kN	
Bucket digging force* SAE : PCSA	95 kN	
Arm crowd force* ISO	93 kN	85 kN
Arm crowd force* SAE : PCSA	90 kN	82 kN

* At power boost

SPECIFICATIONS

WORKING RANGES: MONOBLOCK BOOM

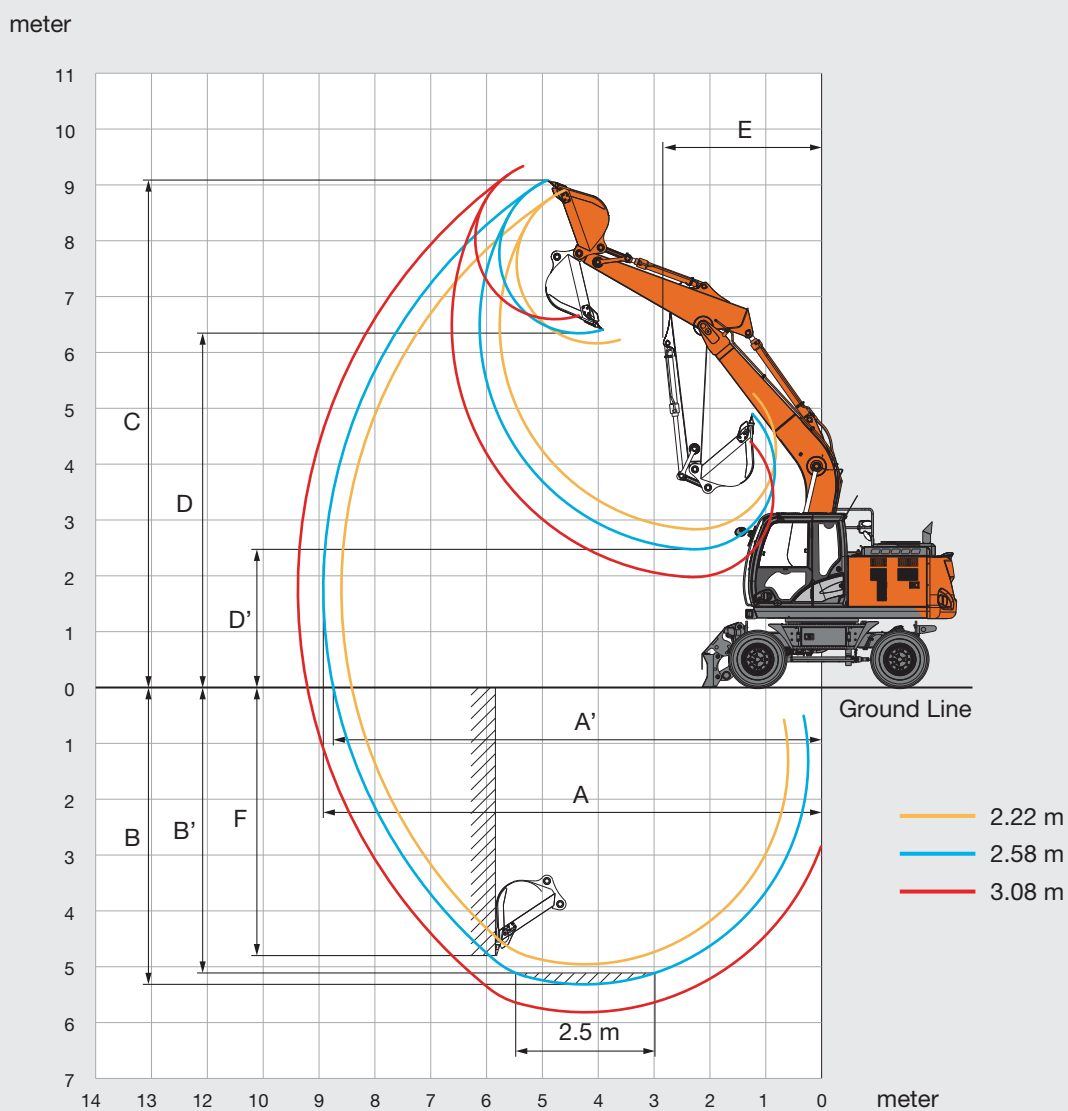

Unit: mm

	ZAXIS 170W		
	Monoblock boom		
Arm length	2.22 m	2.58 m	3.08 m
A Max. digging reach	8 690	9 050	9 500
A' Max. digging reach (on ground)	8 500	8 870	9 330
B Max. digging depth	4 960	5 330	5 830
B' Max. digging depth for 2.5 m level	4 740	5 130	5 650
C Max. cutting height	8 820	9 100	9 360
D Max. dumping height	6 130	6 360	6 610
D' Min. dumping height	2 990	2 480	1 980
E Min. swing radius	3 380	2 940	2 970
F Max. vertical wall digging depth	4 440	4 810	5 320

WORKING RANGES: 2-PIECE BOOM

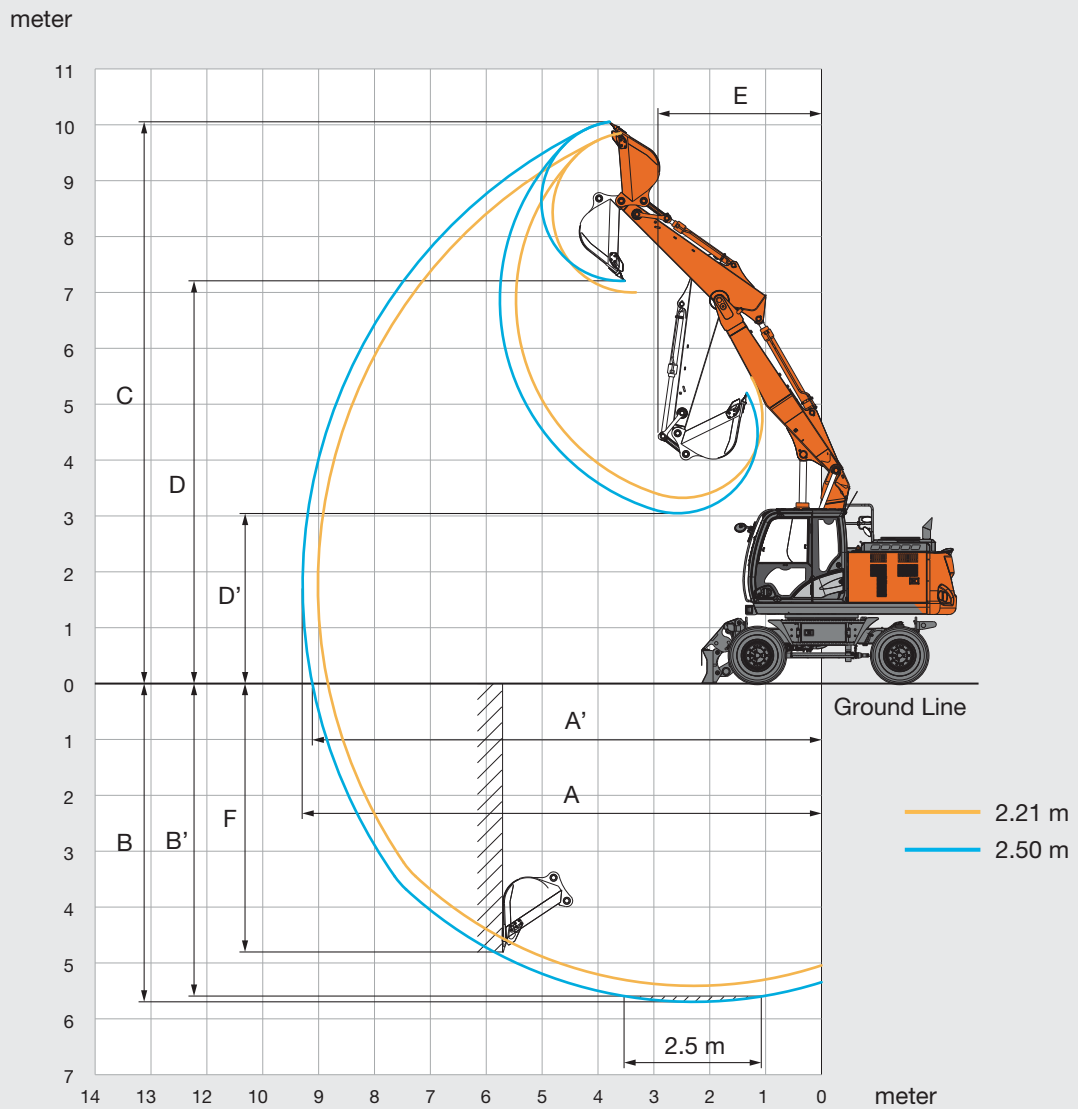

Unit: mm

	ZAXIS 170W	
	2-Piece boom	
Arm length	2.21 m	2.50 m
A Max. digging reach	9 190	9 450
A' Max. digging reach (on ground)	9 010	9 280
B Max. digging depth	5 430	5 720
B' Max. digging depth for 2.5 m level	5 330	5 620
C Max. cutting height	10 010	10 200
D Max. dumping height	7 160	7 340
D' Min. dumping height	3 360	3 050
E Min. swing radius	3 040	3 030
F Max. vertical wall digging depth	4 760	5 050

SPECIFICATIONS

DIMENSIONS

MONOBLOCK BOOM

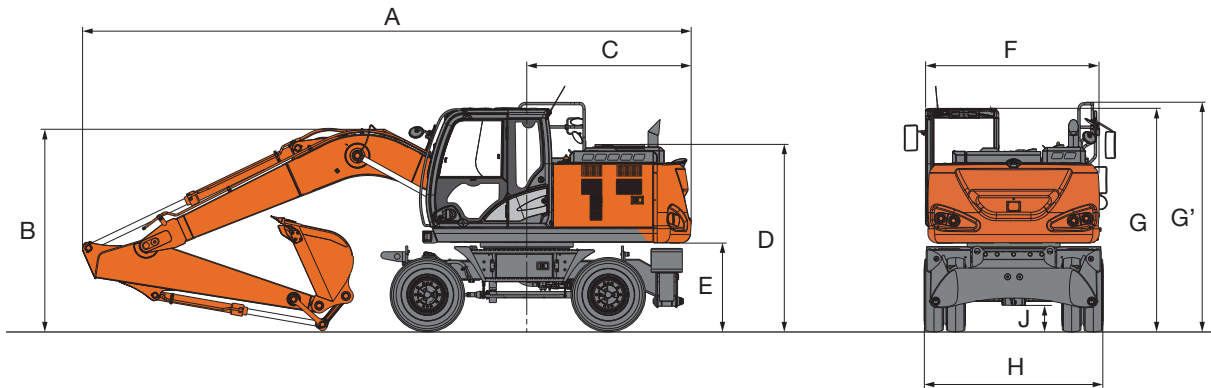

2-PIECE BOOM

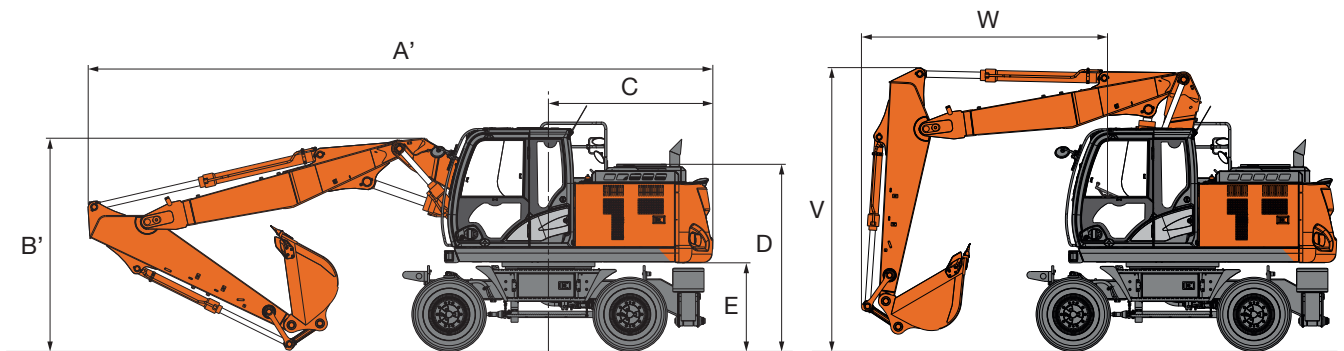

FRONT BLADE AND REAR OUTRIGGER

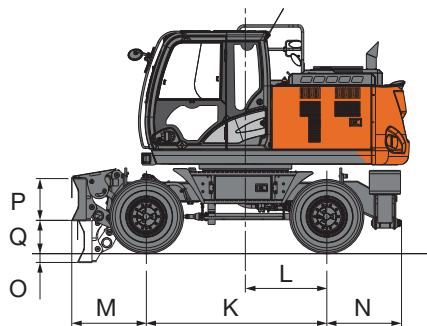

FRONT AND REAR OUTRIGGER

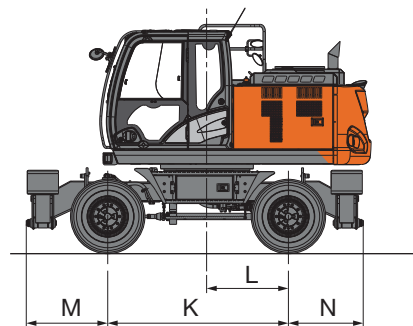

REAR BLADE

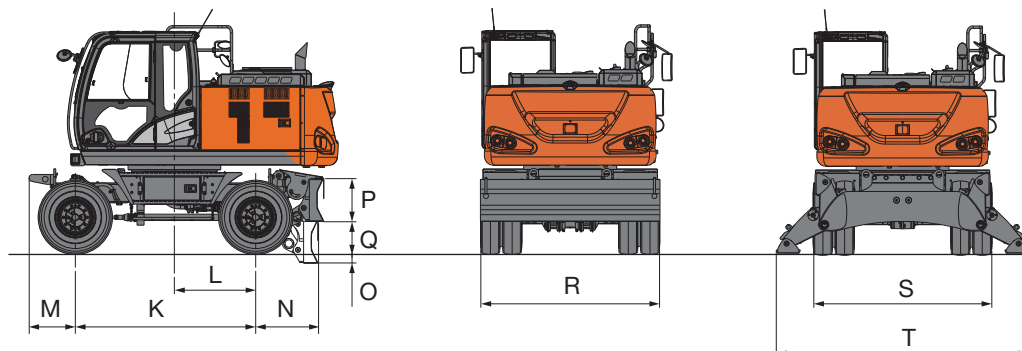

DIMENSIONS

Unit: mm

		Standard gauge / Wide gauge				
		Rear BL	Rear O/R	Front BL Rear O/R	Front O/R Rear BL	Front and Rear O/R
A	Overall length (with monoblock boom)					
	Arm 2.22 m			8 690		
	Arm 2.58 m			8 580		
	Arm 3.08 m			8 520		
A'	Overall length (with 2-piece boom)					
	Arm 2.21 m			8 820		
	Arm 2.50 m			8 810		
B	Overall height of boom (with monoblock boom)					
	Arm 2.22 m			3 190		
	Arm 2.58 m			2 870		
	Arm 3.08 m			3 580		
B'	Overall height of boom (with 2-piece boom)					
	Arm 2.21 m			3 010		
	Arm 2.50 m			3 050		
C	Rear-end swing radius			2 320		
D	Engine cover height			2 590		
E	Counterweight clearance			1 215		
F	Overall width of upper structure			2 450		
G	Overall height of cabin			3 130		
G'	Overall height of handrail			3 220		
H	Overall width tires			2 550 / 2 730		
J	Min. ground clearance			350		
K	Wheel base			2 550		
L	Swing-centre to rear axle			1 150		
M	Front overhang	655		1 055		1 150
N	Rear overhang	965	1 060		965	1 060
O	Max. blade lower	145	–	145		–
P	Height of blade	590	–	590		–
Q	Max. blade raise	445	–	445		–
R	Overall width of blade	2 530 / 2 730	–	2 530 / 2 730		–
S	Overall width of O/R retract	–		2 470		
T	Overall width O/R extend	–		3 380		
V	Overall height of boom (travelling)					
	Arm 2.21 m			3 980		
	Arm 2.50 m			3 980		
W	Front overhang (travelling)					
	Arm 2.21 m			3 070		
	Arm 2.50 m			3 390		

Transportation dimensions are A (A'), B (B'), H (without blade) or A (A'), B (B'), R (with blade).

LIFTING CAPACITIES

- Notes:
1. Ratings are based on ISO 10567.
 2. Lifting capacity does not exceed 75% of tipping load with the machine on firm, level ground or 87% full hydraulic capacity.
 3. The load point is the center-line of the bucket pivot mounting pin on the arm.
 4. *Indicates load limited by hydraulic capacity.
 5. Each value with Rear blade up over the Front-axle side and each value with Rear blade down over the Rear-axle side respectively, and value in optimal position with positioning cylinder.
 6. 0 m = Ground.

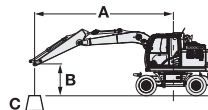

A: Load radius
B: Load point height
C: Lifting capacity



For lifting capacities, subtract bucket and quick hitch weight from lifting capacities without bucket.











ZAXIS 170W MONOBLOCK BOOM, ARM 2.58 M, 3 400 KG COUNTERWEIGHT, STANDARD GAUGE

Rating over-front or rear Rating over-side or 360 degrees Unit : kg



Stabilization		Load radius								At max. reach		
		3.0 m		4.5 m		6.0 m		7.5 m				meter
6.0 m	Rear blade up (over front)					*3 750	2 880			*3 150	2 670	6.27
	Rear blade down (over rear)					*3 750	3 250			*3 150	3 020	
	Rear outrigger down (over rear)					*3 750	*3 750			*3 150	*3 150	
	Front outrigger and rear blade down (over rear)					*3 750	*3 750			*3 150	*3 150	
	Front blade and rear outrigger down (over rear)					*3 750	*3 750			*3 150	*3 150	
	4 outrigger down (over rear)					*3 750	*3 750			*3 150	*3 150	
4.5 m	Rear blade up (over front)			*5 470	4 400	4 410	2 820			*3 090	2 140	7.09
	Rear blade down (over rear)			*5 470	4 990	*4 750	3 190			*3 090	2 430	
	Rear outrigger down (over rear)			*5 470	*5 470	*4 750	3 780			*3 090	2 890	
	Front outrigger and rear blade down (over rear)			*5 470	*5 470	*4 750	4 700			*3 090	*3 090	
	Front blade and rear outrigger down (over rear)			*5 470	*5 470	*4 750	*4 750			*3 090	*3 090	
	4 outrigger down (over rear)			*5 470	*5 470	*4 750	*4 750			*3 090	*3 090	
3.0 m	Rear blade up (over front)			6 600	4 060	4 260	2 680	3 020	1 890	3 020	1 890	7.51
	Rear blade down (over rear)			*6 650	4 640	*5 160	3 050	*3 240	2 160	*3 200	2 160	
	Rear outrigger down (over rear)			*6 650	5 570	*5 160	3 630	*3 240	2 580	*3 200	2 580	
	Front outrigger and rear blade down (over rear)			*6 650	*6 650	*5 160	4 550	*3 240	3 240	*3 200	*3 200	
	Front blade and rear outrigger down (over rear)			*6 650	*6 650	*5 160	4 660	*3 240	*3 240	*3 200	*3 200	
	4 outrigger down (over rear)			*6 650	*6 650	*5 160	*5 160	*3 240	*3 240	*3 200	*3 200	
1.5 m	Rear blade up (over front)			6 220	3 740	4 090	2 530	2 960	1 830	2 900	1 790	7.61
	Rear blade down (over rear)			*7 540	4 300	*5 530	2 900	*4 040	2 100	*3 480	2 060	
	Rear outrigger down (over rear)			*7 540	5 220	*5 530	3 470	*4 040	2 520	*3 480	2 470	
	Front outrigger and rear blade down (over rear)			*7 540	6 690	*5 530	4 380	*4 040	3 170	*3 480	3 110	
	Front blade and rear outrigger down (over rear)			*7 540	6 880	*5 530	4 490	*4 040	3 250	*3 480	3 180	
	4 outrigger down (over rear)			*7 540	*7 540	*5 530	5 240	*4 040	3 770	*3 480	*3 480	
0 m (Ground)	Rear blade up (over front)	*5 430	*5 430	6 010	3 550	3 970	2 420			2 970	1 830	7.40
	Rear blade down (over rear)	*5 430	*5 430	*7 700	4 110	*5 600	2 790			*4 030	2 100	
	Rear outrigger down (over rear)	*5 430	*5 430	*7 700	5 020	*5 600	3 360			*4 030	2 530	
	Front outrigger and rear blade down (over rear)	*5 430	*5 430	*7 700	6 480	*5 600	4 270			*4 030	3 190	
	Front blade and rear outrigger down (over rear)	*5 430	*5 430	*7 700	6 660	*5 600	4 380			*4 030	3 270	
	4 outrigger down (over rear)	*5 430	*5 430	*7 700	*7 700	*5 600	5 110			*4 030	3 790	
-1.5 m	Rear blade up (over front)	*9 650	6 340	5 960	3 500	3 940	2 390			3 300	2 020	6.84
	Rear blade down (over rear)	*9 650	7 510	*7 060	4 060	*5 160	2 750			*4 210	2 320	
	Rear outrigger down (over rear)	*9 650	9 500	*7 060	4 970	*5 160	3 320			*4 210	2 800	
	Front outrigger and rear blade down (over rear)	*9 650	*9 650	*7 060	6 420	*5 160	4 230			*4 210	3 540	
	Front blade and rear outrigger down (over rear)	*9 650	*9 650	*7 060	6 610	*5 160	4 340			*4 210	3 630	
	4 outrigger down (over rear)	*9 650	*9 650	*7 060	*7 060	*5 160	5 070			*4 210	*4 210	
-3.0 m	Rear blade up (over front)	*7 380	6 490	*5 540	3 570					*3 890	2 530	5.85
	Rear blade down (over rear)	*7 380	*7 380	*5 540	4 130					*3 890	2 910	
	Rear outrigger down (over rear)	*7 380	*7 380	*5 540	5 040					*3 890	3 510	
	Front outrigger and rear blade down (over rear)	*7 380	*7 380	*5 540	*5 540					*3 890	*3 890	
	Front blade and rear outrigger down (over rear)	*7 380	*7 380	*5 540	*5 540					*3 890	*3 890	
	4 outrigger down (over rear)	*7 380	*7 380	*5 540	*5 540					*3 890	*3 890	













**ZAXIS 170W MONOBLOCK BOOM, ARM 2.58 M,
3 400 KG COUNTERWEIGHT, WIDE GAUGE**

 Rating over-front or rear  Rating over-side or 360 degrees Unit : kg



Stabilization		Load radius								At max. reach		
		3.0 m		4.5 m		6.0 m		7.5 m				meter
												
6.0 m	Rear blade up (over front)					*3 750	3 140			*3 150	2 910	6.27
	Rear blade down (over rear)					*3 750	3 550			*3 150	*3 150	
	Rear outrigger down (over rear)					*3 750	*3 750			*3 150	*3 150	
	Front outrigger and rear blade down (over rear)					*3 750	*3 750			*3 150	*3 150	
	Front blade and rear outrigger down (over rear)					*3 750	*3 750			*3 150	*3 150	
	4 outrigger down (over rear)					*3 750	*3 750			*3 150	*3 150	
4.5 m	Rear blade up (over front)			*5 470	4 810	4 410	3 080			*3 090	2 340	7.09
	Rear blade down (over rear)			*5 470	5 460	*4 750	3 480			*3 090	2 660	
	Rear outrigger down (over rear)			*5 470	*5 470	*4 750	3 950			*3 090	3 020	
	Front outrigger and rear blade down (over rear)			*5 470	*5 470	*4 750	*4 750			*3 090	*3 090	
	Front blade and rear outrigger down (over rear)			*5 470	*5 470	*4 750	*4 750			*3 090	*3 090	
	4 outrigger down (over rear)			*5 470	*5 470	*4 750	*4 750			*3 090	*3 090	
3.0 m	Rear blade up (over front)			6 600	4 470	4 260	2 940	3 020	2 080	3 020	2 080	7.51
	Rear blade down (over rear)			*6 650	5 110	*5 160	3 340	*3 240	2 370	*3 200	2 370	
	Rear outrigger down (over rear)			*6 650	5 850	*5 160	3 800	*3 240	2 700	*3 200	2 700	
	Front outrigger and rear blade down (over rear)			*6 650	*6 650	*5 160	4 760	*3 240	*3 240	*3 200	*3 200	
	Front blade and rear outrigger down (over rear)			*6 650	*6 650	*5 160	4 840	*3 240	*3 240	*3 200	*3 200	
	4 outrigger down (over rear)			*6 650	*6 650	*5 160	*5 160	*3 240	*3 240	*3 200	*3 200	
1.5 m	Rear blade up (over front)			6 220	4 130	4 090	2 790	2 960	2 020	2 900	1 980	7.61
	Rear blade down (over rear)			*7 540	4 760	*5 530	3 180	*4 040	2 310	*3 480	2 260	
	Rear outrigger down (over rear)			*7 540	5 490	*5 530	3 640	*4 040	2 640	*3 480	2 590	
	Front outrigger and rear blade down (over rear)			*7 540	7 030	*5 530	4 590	*4 040	3 310	*3 480	3 250	
	Front blade and rear outrigger down (over rear)			*7 540	7 180	*5 530	4 670	*4 040	3 370	*3 480	3 300	
	4 outrigger down (over rear)			*7 540	*7 540	*5 530	5 230	*4 040	3 770	*3 480	*3 480	
0 m (Ground)	Rear blade up (over front)	*5 430	*5 430	6 010	3 940	3 980	2 680			2 970	2 020	7.40
	Rear blade down (over rear)	*5 430	*5 430	*7 700	4 560	*5 600	3 070			*4 030	2 310	
	Rear outrigger down (over rear)	*5 430	*5 430	*7 700	5 290	*5 600	3 530			*4 030	2 650	
	Front outrigger and rear blade down (over rear)	*5 430	*5 430	*7 700	6 820	*5 600	4 470			*4 030	3 330	
	Front blade and rear outrigger down (over rear)	*5 430	*5 430	*7 700	6 960	*5 600	4 550			*4 030	3 390	
	4 outrigger down (over rear)	*5 430	*5 430	*7 700	*7 700	*5 600	5 110			*4 030	3 790	
-1.5 m	Rear blade up (over front)	*9 650	7 150	5 960	3 900	3 940	2 640			3 300	2 230	6.84
	Rear blade down (over rear)	*9 650	8 500	*7 060	4 510	*5 160	3 030			*4 210	2 560	
	Rear outrigger down (over rear)	*9 650	*9 650	*7 060	5 240	*5 160	3 490			*4 210	2 930	
	Front outrigger and rear blade down (over rear)	*9 650	*9 650	*7 060	6 760	*5 160	4 430			*4 210	3 700	
	Front blade and rear outrigger down (over rear)	*9 650	*9 650	*7 060	6 900	*5 160	4 510			*4 210	3 770	
	4 outrigger down (over rear)	*9 650	*9 650	*7 060	*7 060	*5 160	5 070			*4 210	*4 210	
-3.0 m	Rear blade up (over front)	*7 380	7 310	*5 540	3 960					*3 890	2 800	5.85
	Rear blade down (over rear)	*7 380	*7 380	*5 540	4 580					*3 890	3 210	
	Rear outrigger down (over rear)	*7 380	*7 380	*5 540	5 310					*3 890	3 680	
	Front outrigger and rear blade down (over rear)	*7 380	*7 380	*5 540	*5 540					*3 890	*3 890	
	Front blade and rear outrigger down (over rear)	*7 380	*7 380	*5 540	*5 540					*3 890	*3 890	
	4 outrigger down (over rear)	*7 380	*7 380	*5 540	*5 540					*3 890	*3 890	













**ZAXIS 170W 2-PIECE BOOM, ARM 2.50 M,
3 400 KG COUNTERWEIGHT, STANDARD GAUGE**

 Rating over-front or rear  Rating over-side or 360 degrees Unit : kg



Stabilization		Load radius										At max. reach		
		1.5 m		3.0 m		4.5 m		6.0 m		7.5 m				meter
														
7.5 m	Rear blade up (over front)					*4 260	*4 260					*2 440	*2 440	5.48
	Rear blade down (over rear)					*4 260	*4 260					*2 440	*2 440	
	Rear outrigger down (over rear)					*4 260	*4 260					*2 440	*2 440	
	Front outrigger and rear blade down (over rear)					*4 260	*4 260					*2 440	*2 440	
	Front blade and rear outrigger down (over rear)					*4 260	*4 260					*2 440	*2 440	
	4 outrigger down (over rear)					*4 260	*4 260					*2 440	*2 440	
6.0 m	Rear blade up (over front)					*4 350	*4 350	*4 070	2 950			*2 120	*2 120	6.76
	Rear blade down (over rear)					*4 350	*4 350	*4 070	3 330			*2 120	*2 120	
	Rear outrigger down (over rear)					*4 350	*4 350	*4 070	3 910			*2 120	*2 120	
	Front outrigger and rear blade down (over rear)					*4 350	*4 350	*4 070	*4 070			*2 120	*2 120	
	Front blade and rear outrigger down (over rear)					*4 350	*4 350	*4 070	*4 070			*2 120	*2 120	
	4 outrigger down (over rear)					*4 350	*4 350	*4 070	*4 070			*2 120	*2 120	
4.5 m	Rear blade up (over front)			*6 550	*6 550	*5 090	4 480	*4 320	3 000	*2 160	1 910	*2 000	1 900	7.52
	Rear blade down (over rear)			*6 550	*6 550	*5 090	5 010	*4 320	3 340	*2 160	*2 160	*2 000	*2 000	
	Rear outrigger down (over rear)			*6 550	*6 550	*5 090	*5 090	*4 320	3 870	*2 160	*2 160	*2 000	*2 000	
	Front outrigger and rear blade down (over rear)			*6 550	*6 550	*5 090	*5 090	*4 320	*4 320	*2 160	*2 160	*2 000	*2 000	
	Front blade and rear outrigger down (over rear)			*6 550	*6 550	*5 090	*5 090	*4 320	*4 320	*2 160	*2 160	*2 000	*2 000	
	4 outrigger down (over rear)			*6 550	*6 550	*5 090	*5 090	*4 320	*4 320	*2 160	*2 160	*2 000	*2 000	
3.0 m	Rear blade up (over front)			*7 610	7 600	*6 240	4 340	*4 350	*2 980	3 060	1 910	*1 990	1 690	7.92
	Rear blade down (over rear)			*7 610	*7 610	*6 240	4 860	*4 790	3 310	*4 040	2 190	*1 990	1 950	
	Rear outrigger down (over rear)			*7 610	*7 610	*6 240	*5 660	*4 790	3 820	*4 040	2 620	*1 990	*1 990	
	Front outrigger and rear blade down (over rear)			*7 610	*7 610	*6 240	*6 240	*4 790	4 600	*4 040	3 270	*1 990	*1 990	
	Front blade and rear outrigger down (over rear)			*7 610	*7 610	*6 240	*6 240	*4 790	*4 690	*4 040	3 350	*1 990	*1 990	
	4 outrigger down (over rear)			*7 610	*7 610	*6 240	*6 240	*4 790	*4 790	*4 040	3 860	*1 990	*1 990	
1.5 m	Rear blade up (over front)			*9 570	7 490	*6 420	*4 290	*4 340	2 890	3 000	1 860	*2 080	1 620	8.02
	Rear blade down (over rear)			*9 570	8 520	*7 210	4 800	*5 250	3 270	*4 240	2 140	*2 080	1 870	
	Rear outrigger down (over rear)			*9 570	*9 570	*7 210	5 590	*5 250	3 830	*4 240	2 560	*2 080	*2 080	
	Front outrigger and rear blade down (over rear)			*9 570	*9 570	*7 210	*6 780	*5 250	4 570	*4 240	3 220	*2 080	*2 080	
	Front blade and rear outrigger down (over rear)			*9 570	*9 570	*7 210	6 920	*5 250	4 660	*4 240	3 290	*2 080	*2 080	
	4 outrigger down (over rear)			*9 570	*9 570	*7 210	*7 210	*5 250	*5 240	*4 240	3 810	*2 080	*2 080	
0 m (Ground)	Rear blade up (over front)	*8 340	*8 340	*11 270	7 530	6 470	4 230	4 310	2 730	2 930	1 780	*2 280	1 640	7.82
	Rear blade down (over rear)	*8 340	*8 340	*11 270	8 640	*7 520	4 830	*5 460	3 100	*4 250	2 050	*2 280	1 900	
	Rear outrigger down (over rear)	*8 340	*8 340	*11 270	10 330	*7 520	*5 650	*5 460	3 680	*4 250	2 480	*2 280	*2 280	
	Front outrigger and rear blade down (over rear)	*8 340	*8 340	*11 270	*11 270	*7 520	*6 830	*5 460	4 600	*4 250	3 140	*2 280	*2 280	
	Front blade and rear outrigger down (over rear)	*8 340	*8 340	*11 270	*11 270	*7 520	6 970	*5 460	4 710	*4 250	3 220	*2 280	*2 280	
	4 outrigger down (over rear)	*8 340	*8 340	*11 270	*11 270	*7 520	*7 520	*5 460	*5 270	*4 250	3 730	*2 280	*2 280	
-1.5 m	Rear blade up (over front)	*13 490	*13 490	*12 170	7 190	6 630	4 040	4 130	2 540			*2 670	1 810	7.29
	Rear blade down (over rear)	*13 490	*13 490	*12 170	8 450	*7 640	4 630	*5 600	2 910			*2 670	2 090	
	Rear outrigger down (over rear)	*13 490	*13 490	*12 170	10 560	*7 640	5 590	*5 600	3 500			*2 670	2 540	
	Front outrigger and rear blade down (over rear)	*13 490	*13 490	*12 170	*12 170	*7 640	*7 080	*5 600	4 420			*2 670	*2 670	
	Front blade and rear outrigger down (over rear)	*13 490	*13 490	*12 170	*12 170	*7 640	*7 190	*5 600	4 530			*2 670	*2 670	
	4 outrigger down (over rear)	*13 490	*13 490	*12 170	*12 170	*7 640	*7 640	*5 600	5 280			*2 670	*2 670	
-3.0 m	Rear blade up (over front)	*21 490	*21 490	*12 680	7 150	6 360	3 800	4 020	2 430			*3 750	2 340	6.15
	Rear blade down (over rear)	*21 490	*21 490	*12 680	8 400	*7 780	4 390	*4 610	2 800			*3 750	2 700	
	Rear outrigger down (over rear)	*21 490	*21 490	*12 680	10 510	*7 780	5 330	*4 610	3 390			*3 750	3 270	
	Front outrigger and rear blade down (over rear)	*21 490	*21 490	*12 680	*12 680	*7 780	6 830	*4 610	4 310			*3 750	*3 750	
	Front blade and rear outrigger down (over rear)	*21 490	*21 490	*12 680	*12 680	*7 780	7 020	*4 610	4 420			*3 750	*3 750	
	4 outrigger down (over rear)	*21 490	*21 490	*12 680	*12 680	*7 780	*7 780	*4 610	*4 610			*3 750	*3 750	











**ZAXIS 170W 2-PIECE BOOM, ARM 2.50 M,
3 400 KG COUNTERWEIGHT, WIDE GAUGE**

 Rating over-front or rear  Rating over-side or 360 degrees Unit : kg



Stabilization		Load radius										At max. reach		
		1.5 m		3.0 m		4.5 m		6.0 m		7.5 m				meter
														
7.5 m	Rear blade up (over front)					*4 260	*4 260					*2 440	*2 440	5.48
	Rear blade down (over rear)					*4 260	*4 260					*2 440	*2 440	
	Rear outrigger down (over rear)					*4 260	*4 260					*2 440	*2 440	
	Front outrigger and rear blade down (over rear)					*4 260	*4 260					*2 440	*2 440	
	Front blade and rear outrigger down (over rear)					*4 260	*4 260					*2 440	*2 440	
	4 outrigger down (over rear)					*4 260	*4 260					*2 440	*2 440	
6.0 m	Rear blade up (over front)					*4 350	*4 350	*4 070	3 220			*2 120	*2 120	6.76
	Rear blade down (over rear)					*4 350	*4 350	*4 070	3 630			*2 120	*2 120	
	Rear outrigger down (over rear)					*4 350	*4 350	*4 070	4 070			*2 120	*2 120	
	Front outrigger and rear blade down (over rear)					*4 350	*4 350	*4 070	*4 070			*2 120	*2 120	
	Front blade and rear outrigger down (over rear)					*4 350	*4 350	*4 070	*4 070			*2 120	*2 120	
	4 outrigger down (over rear)					*4 350	*4 350	*4 070	*4 070			*2 120	*2 120	
4.5 m	Rear blade up (over front)			*6 550	*6 550	*5 090	4 850	*4 320	*3 240	*2 160	2 110	*2 000	*2 000	7.52
	Rear blade down (over rear)			*6 550	*6 550	*5 090	*5 090	*4 320	3 610	*2 160	*2 160	*2 000	*2 000	
	Rear outrigger down (over rear)			*6 550	*6 550	*5 090	*5 090	*4 320	4 020	*2 160	*2 160	*2 000	*2 000	
	Front outrigger and rear blade down (over rear)			*6 550	*6 550	*5 090	*5 090	*4 320	*4 320	*2 160	*2 160	*2 000	*2 000	
	Front blade and rear outrigger down (over rear)			*6 550	*6 550	*5 090	*5 090	*4 320	*4 320	*2 160	*2 160	*2 000	*2 000	
	4 outrigger down (over rear)			*6 550	*6 550	*5 090	*5 090	*4 320	*4 320	*2 160	*2 160	*2 000	*2 000	
3.0 m	Rear blade up (over front)			*7 610	*7 610	*6 240	4 700	*4 350	3 210	3 060	2 110	*1 990	1 870	7.92
	Rear blade down (over rear)			*7 610	*7 610	*6 240	5 260	*4 790	3 560	*4 040	2 400	*1 990	*1 990	
	Rear outrigger down (over rear)			*7 610	*7 610	*6 240	5 900	*4 790	3 970	*4 040	2 740	*1 990	*1 990	
	Front outrigger and rear blade down (over rear)			*7 610	*7 610	*6 240	*6 240	*4 790	*4 770	*4 040	3 410	*1 990	*1 990	
	Front blade and rear outrigger down (over rear)			*7 610	*7 610	*6 240	*6 240	*4 790	*4 790	*4 040	3 470	*1 990	*1 990	
	4 outrigger down (over rear)			*7 610	*7 610	*6 240	*6 240	*4 790	*4 790	*4 040	3 860	*1 990	*1 990	
1.5 m	Rear blade up (over front)			*9 570	8 200	*6 420	4 650	*4 340	3 150	3 010	2 050	*2 080	1 790	8.02
	Rear blade down (over rear)			*9 570	9 380	*7 210	5 200	*5 250	3 560	*4 240	2 350	*2 080	2 060	
	Rear outrigger down (over rear)			*9 570	*9 570	*7 210	5 820	*5 250	3 970	*4 240	2 680	*2 080	*2 080	
	Front outrigger and rear blade down (over rear)			*9 570	*9 570	*7 210	7 040	*5 250	4 740	*4 240	3 360	*2 080	*2 080	
	Front blade and rear outrigger down (over rear)			*9 570	*9 570	*7 210	*7 150	*5 250	4 810	*4 240	3 420	*2 080	*2 080	
	4 outrigger down (over rear)			*9 570	*9 570	*7 210	*7 210	*5 250	*5 240	*4 240	3 810	*2 080	*2 080	
0 m (Ground)	Rear blade up (over front)	*8 340	*8 340	*11 270	8 330	6 470	4 650	4 310	2 990	2 930	1 970	*2 280	1 830	7.82
	Rear blade down (over rear)	*8 340	*8 340	*11 270	9 500	*7 520	5 270	*5 460	3 390	*4 250	2 270	*2 280	2 110	
	Rear outrigger down (over rear)	*8 340	*8 340	*11 270	10 830	*7 520	5 880	*5 460	3 860	*4 250	2 600	*2 280	*2 280	
	Front outrigger and rear blade down (over rear)	*8 340	*8 340	*11 270	*11 270	*7 520	*7 090	*5 460	4 810	*4 250	3 280	*2 280	*2 280	
	Front blade and rear outrigger down (over rear)	*8 340	*8 340	*11 270	*11 270	*7 520	*7 190	*5 460	4 890	*4 250	3 340	*2 280	*2 280	
	4 outrigger down (over rear)	*8 340	*8 340	*11 270	*11 270	*7 520	*7 520	*5 460	*5 270	*4 250	3 730	*2 280	*2 280	
-1.5 m	Rear blade up (over front)	*13 490	*13 490	*12 170	8 060	6 630	4 450	4 130	2 800			*2 670	2 010	7.29
	Rear blade down (over rear)	*13 490	*13 490	*12 170	9 510	*7 640	5 110	*5 600	3 210			*2 670	2 310	
	Rear outrigger down (over rear)	*13 490	*13 490	*12 170	*11 160	*7 640	5 870	*5 600	3 670			*2 670	2 660	
	Front outrigger and rear blade down (over rear)	*13 490	*13 490	*12 170	*12 170	*7 640	7 290	*5 600	4 620			*2 670	*2 670	
	Front blade and rear outrigger down (over rear)	*13 490	*13 490	*12 170	*12 170	*7 640	7 380	*5 600	4 710			*2 670	*2 670	
	4 outrigger down (over rear)	*13 490	*13 490	*12 170	*12 170	*7 640	*7 640	*5 600	5 270			*2 670	*2 670	
-3.0 m	Rear blade up (over front)	*21 490	*21 490	*12 680	8 020	6 360	4 210	4 020	2 690			*3 750	2 590	6.15
	Rear blade down (over rear)	*21 490	*21 490	*12 680	9 460	*7 780	4 860	*4 610	3 090			*3 750	2 980	
	Rear outrigger down (over rear)	*21 490	*21 490	*12 680	11 190	*7 780	5 610	*4 610	3 560			*3 750	3 430	
	Front outrigger and rear blade down (over rear)	*21 490	*21 490	*12 680	*12 680	*7 780	7 190	*4 610	4 520			*3 750	*3 750	
	Front blade and rear outrigger down (over rear)	*21 490	*21 490	*12 680	*12 680	*7 780	7 330	*4 610	4 600			*3 750	*3 750	
	4 outrigger down (over rear)	*21 490	*21 490	*12 680	*12 680	*7 780	*7 780	*4 610	*4 610			*3 750	*3 750	











**ZAXIS 170W MONOBLOCK BOOM, ARM 2.58 M,
3 800 KG COUNTERWEIGHT, STANDARD GAUGE**

 Rating over-front or rear  Rating over-side or 360 degrees Unit : kg



Stabilization		Load radius								At max. reach		meter
		3.0 m		4.5 m		6.0 m		7.5 m				
												
6.0 m	Rear blade up (over front)					*3 750	3 060			*3 150	2 840	6.27
	Rear blade down (over rear)					*3 750	3 440			*3 150	*3 150	
	Rear outrigger down (over rear)					*3 750	*3 750			*3 150	*3 150	
	Front outrigger and rear blade down (over rear)					*3 750	*3 750			*3 150	*3 150	
	Front blade and rear outrigger down (over rear)					*3 750	*3 750			*3 150	*3 150	
	4 outrigger down (over rear)					*3 750	*3 750			*3 150	*3 150	
4.5 m	Rear blade up (over front)			*5 470	4 650	4 630	2 990			*3 090	2 280	7.09
	Rear blade down (over rear)			*5 470	5 260	*4 750	3 380			*3 090	2 580	
	Rear outrigger down (over rear)			*5 470	*5 470	*4 750	3 980			*3 090	3 050	
	Front outrigger and rear blade down (over rear)			*5 470	*5 470	*4 750	*4 750			*3 090	*3 090	
	Front blade and rear outrigger down (over rear)			*5 470	*5 470	*4 750	*4 750			*3 090	*3 090	
	4 outrigger down (over rear)			*5 470	*5 470	*4 750	*4 750			*3 090	*3 090	
3.0 m	Rear blade up (over front)			*6 650	4 310	4 480	2 860	3 190	2 030	3 190	2 020	7.51
	Rear blade down (over rear)			*6 650	4 910	*5 160	3 240	*3 240	2 310	*3 200	2 300	
	Rear outrigger down (over rear)			*6 650	5 870	*5 160	3 840	*3 240	2 740	*3 200	2 730	
	Front outrigger and rear blade down (over rear)			*6 650	*6 650	*5 160	4 780	*3 240	*3 240	*3 200	*3 200	
	Front blade and rear outrigger down (over rear)			*6 650	*6 650	*5 160	4 890	*3 240	*3 240	*3 200	*3 200	
	4 outrigger down (over rear)			*6 650	*6 650	*5 160	*5 160	*3 240	*3 240	*3 200	*3 200	
1.5 m	Rear blade up (over front)			6 550	3 990	4 310	2 710	3 130	1 970	3 060	1 930	7.61
	Rear blade down (over rear)			*7 540	4 570	*5 530	3 080	*4 040	2 240	*3 480	2 200	
	Rear outrigger down (over rear)			*7 540	5 520	*5 530	3 680	*4 040	2 680	*3 480	2 620	
	Front outrigger and rear blade down (over rear)			*7 540	7 030	*5 530	4 610	*4 040	3 340	*3 480	3 280	
	Front blade and rear outrigger down (over rear)			*7 540	7 220	*5 530	4 720	*4 040	3 420	*3 480	3 350	
	4 outrigger down (over rear)			*7 540	*7 540	*5 530	5 490	*4 040	3 950	*3 480	*3 480	
0 m (Ground)	Rear blade up (over front)	*5 430	*5 430	6 340	3 800	4 200	2 600			3 140	1 970	7.40
	Rear blade down (over rear)	*5 430	*5 430	*7 700	4 380	*5 600	2 970			*4 030	2 250	
	Rear outrigger down (over rear)	*5 430	*5 430	*7 700	5 320	*5 600	3 570			*4 030	2 680	
	Front outrigger and rear blade down (over rear)	*5 430	*5 430	*7 700	6 820	*5 600	4 490			*4 030	3 360	
	Front blade and rear outrigger down (over rear)	*5 430	*5 430	*7 700	7 010	*5 600	4 610			*4 030	3 440	
	4 outrigger down (over rear)	*5 430	*5 430	*7 700	*7 700	*5 600	5 360			*4 030	3 980	
-1.5 m	Rear blade up (over front)	*9 650	6 770	6 290	3 760	4 160	2 560			3 490	2 170	6.84
	Rear blade down (over rear)	*9 650	8 000	*7 060	4 340	*5 160	2 940			*4 210	2 480	
	Rear outrigger down (over rear)	*9 650	*9 650	*7 060	5 270	*5 160	3 530			*4 210	2 970	
	Front outrigger and rear blade down (over rear)	*9 650	*9 650	*7 060	6 760	*5 160	4 450			*4 210	3 730	
	Front blade and rear outrigger down (over rear)	*9 650	*9 650	*7 060	6 950	*5 160	4 570			*4 210	3 820	
	4 outrigger down (over rear)	*9 650	*9 650	*7 060	*7 060	*5 160	*5 160			*4 210	*4 210	
-3.0 m	Rear blade up (over front)	*7 380	6 920	*5 540	3 820					*3 890	2 720	5.85
	Rear blade down (over rear)	*7 380	*7 380	*5 540	4 400					*3 890	3 110	
	Rear outrigger down (over rear)	*7 380	*7 380	*5 540	5 340					*3 890	3 720	
	Front outrigger and rear blade down (over rear)	*7 380	*7 380	*5 540	*5 540					*3 890	*3 890	
	Front blade and rear outrigger down (over rear)	*7 380	*7 380	*5 540	*5 540					*3 890	*3 890	
	4 outrigger down (over rear)	*7 380	*7 380	*5 540	*5 540					*3 890	*3 890	













**ZAXIS 170W MONOBLOCK BOOM, ARM 2.58 M,
3 800 KG COUNTERWEIGHT, WIDE GAUGE**

 Rating over-front or rear  Rating over-side or 360 degrees Unit : kg



Stabilization		Load radius								At max. reach		meter
		3.0 m		4.5 m		6.0 m		7.5 m				
												
6.0 m	Rear blade up (over front)					*3 750	3 330			*3 150	3 090	6.27
	Rear blade down (over rear)					*3 750	*3 750			*3 150	*3 150	
	Rear outrigger down (over rear)					*3 750	*3 750			*3 150	*3 150	
	Front outrigger and rear blade down (over rear)					*3 750	*3 750			*3 150	*3 150	
	Front blade and rear outrigger down (over rear)					*3 750	*3 750			*3 150	*3 150	
	4 outrigger down (over rear)					*3 750	*3 750			*3 150	*3 150	
4.5 m	Rear blade up (over front)			*5 470	5 070	4 630	3 260			*3 090	2 490	7.09
	Rear blade down (over rear)			*5 470	*5 470	*4 750	3 680			*3 090	2 820	
	Rear outrigger down (over rear)			*5 470	*5 470	*4 750	4 160			*3 090	*3 090	
	Front outrigger and rear blade down (over rear)			*5 470	*5 470	*4 750	*4 750			*3 090	*3 090	
	Front blade and rear outrigger down (over rear)			*5 470	*5 470	*4 750	*4 750			*3 090	*3 090	
	4 outrigger down (over rear)			*5 470	*5 470	*4 750	*4 750			*3 090	*3 090	
3.0 m	Rear blade up (over front)			*6 650	4 730	4 480	3 120	3 190	2 220	3 190	2 220	7.51
	Rear blade down (over rear)			*6 650	5 390	*5 160	3 540	*3 240	2 520	*3 200	2 520	
	Rear outrigger down (over rear)			*6 650	6 160	*5 160	4 010	*3 240	2 860	*3 200	2 860	
	Front outrigger and rear blade down (over rear)			*6 650	*6 650	*5 160	4 990	*3 240	*3 240	*3 200	*3 200	
	Front blade and rear outrigger down (over rear)			*6 650	*6 650	*5 160	5 080	*3 240	*3 240	*3 200	*3 200	
	4 outrigger down (over rear)			*6 650	*6 650	*5 160	*5 160	*3 240	*3 240	*3 200	*3 200	
1.5 m	Rear blade up (over front)			6 550	4 400	4 310	2 970	3 130	2 160	3 060	2 120	7.61
	Rear blade down (over rear)			*7 540	5 050	*5 530	3 380	*4 040	2 460	*3 480	2 410	
	Rear outrigger down (over rear)			*7 540	5 800	*5 530	3 850	*4 040	2 800	*3 480	2 740	
	Front outrigger and rear blade down (over rear)			*7 540	7 380	*5 530	4 820	*4 040	3 490	*3 480	3 420	
	Front blade and rear outrigger down (over rear)			*7 540	7 530	*5 530	4 910	*4 040	3 550	*3 480	3 480	
	4 outrigger down (over rear)			*7 540	*7 540	*5 530	5 490	*4 040	3 950	*3 480	*3 480	
0 m (Ground)	Rear blade up (over front)	*5 430	*5 430	6 340	4 210	4 200	2 860			3 140	2 160	7.40
	Rear blade down (over rear)	*5 430	*5 430	*7 700	4 850	*5 600	3 270			*4 030	2 460	
	Rear outrigger down (over rear)	*5 430	*5 430	*7 700	5 600	*5 600	3 740			*4 030	2 810	
	Front outrigger and rear blade down (over rear)	*5 430	*5 430	*7 700	7 170	*5 600	4 700			*4 030	3 510	
	Front blade and rear outrigger down (over rear)	*5 430	*5 430	*7 700	7 310	*5 600	4 790			*4 030	3 570	
	4 outrigger down (over rear)	*5 430	*5 430	*7 700	*7 700	*5 600	5 360			*4 030	3 980	
-1.5 m	Rear blade up (over front)	*9 650	7 620	6 290	4 160	4 160	2 830			3 490	2 390	6.84
	Rear blade down (over rear)	*9 650	9 020	*7 060	4 800	*5 160	3 230			*4 210	2 730	
	Rear outrigger down (over rear)	*9 650	*9 650	*7 060	5 540	*5 160	3 700			*4 210	3 110	
	Front outrigger and rear blade down (over rear)	*9 650	*9 650	*7 060	*7 060	*5 160	4 660			*4 210	3 900	
	Front blade and rear outrigger down (over rear)	*9 650	*9 650	*7 060	*7 060	*5 160	4 750			*4 210	3 970	
	4 outrigger down (over rear)	*9 650	*9 650	*7 060	*7 060	*5 160	*5 160			*4 210	*4 210	
-3.0 m	Rear blade up (over front)	*7 380	*7 380	*5 540	4 230					*3 890	2 990	5.85
	Rear blade down (over rear)	*7 380	*7 380	*5 540	4 870					*3 890	3 410	
	Rear outrigger down (over rear)	*7 380	*7 380	*5 540	*5 540					*3 890	*3 890	
	Front outrigger and rear blade down (over rear)	*7 380	*7 380	*5 540	*5 540					*3 890	*3 890	
	Front blade and rear outrigger down (over rear)	*7 380	*7 380	*5 540	*5 540					*3 890	*3 890	
	4 outrigger down (over rear)	*7 380	*7 380	*5 540	*5 540					*3 890	*3 890	













**ZAXIS 170W 2-PIECE BOOM, ARM 2.50 M,
3 800 KG COUNTERWEIGHT, STANDARD GAUGE**

 Rating over-front or rear  Rating over-side or 360 degrees Unit : kg

Stabilization		Load radius										At max. reach		
		1.5 m		3.0 m		4.5 m		6.0 m		7.5 m				meter
														
7.5 m	Rear blade up (over front)					*4 260	*4 260					*2 440	*2 440	5.48
	Rear blade down (over rear)					*4 260	*4 260					*2 440	*2 440	
	Rear outrigger down (over rear)					*4 260	*4 260					*2 440	*2 440	
	Front outrigger and rear blade down (over rear)					*4 260	*4 260					*2 440	*2 440	
	Front blade and rear outrigger down (over rear)					*4 260	*4 260					*2 440	*2 440	
	4 outrigger down (over rear)					*4 260	*4 260					*2 440	*2 440	
6.0 m	Rear blade up (over front)					*4 350	*4 350	*4 070	3 130			*2 120	*2 120	6.76
	Rear blade down (over rear)					*4 350	*4 350	*4 070	3 520			*2 120	*2 120	
	Rear outrigger down (over rear)					*4 350	*4 350	*4 070	*4 070			*2 120	*2 120	
	Front outrigger and rear blade down (over rear)					*4 350	*4 350	*4 070	*4 070			*2 120	*2 120	
	Front blade and rear outrigger down (over rear)					*4 350	*4 350	*4 070	*4 070			*2 120	*2 120	
	4 outrigger down (over rear)					*4 350	*4 350	*4 070	*4 070			*2 120	*2 120	
4.5 m	Rear blade up (over front)			*6 550	*6 550	*5 090	4 700	*4 320	*3 160	*2 160	2 050	*2 000	*2 000	7.52
	Rear blade down (over rear)			*6 550	*6 550	*5 090	*5 090	*4 320	3 510	*2 160	*2 160	*2 000	*2 000	
	Rear outrigger down (over rear)			*6 550	*6 550	*5 090	*5 090	*4 320	4 050	*2 160	*2 160	*2 000	*2 000	
	Front outrigger and rear blade down (over rear)			*6 550	*6 550	*5 090	*5 090	*4 320	*4 320	*2 160	*2 160	*2 000	*2 000	
	Front blade and rear outrigger down (over rear)			*6 550	*6 550	*5 090	*5 090	*4 320	*4 320	*2 160	*2 160	*2 000	*2 000	
	4 outrigger down (over rear)			*6 550	*6 550	*5 090	*5 090	*4 320	*4 320	*2 160	*2 160	*2 000	*2 000	
3.0 m	Rear blade up (over front)			*7 610	*7 610	*6 240	4 560	4 540	3 130	3 220	2 050	*1 990	1 820	7.92
	Rear blade down (over rear)			*7 610	*7 610	*6 240	5 090	*4 790	3 460	*4 040	2 330	*1 990	*1 990	
	Rear outrigger down (over rear)			*7 610	*7 610	*6 240	5 900	*4 790	3 990	*4 040	2 770	*1 990	*1 990	
	Front outrigger and rear blade down (over rear)			*7 610	*7 610	*6 240	*6 240	*4 790	4 790	*4 040	3 440	*1 990	*1 990	
	Front blade and rear outrigger down (over rear)			*7 610	*7 610	*6 240	*6 240	*4 790	*4 790	*4 040	3 520	*1 990	*1 990	
	4 outrigger down (over rear)			*7 610	*7 610	*6 240	*6 240	*4 790	*4 790	*4 040	4 040	*1 990	*1 990	
1.5 m	Rear blade up (over front)			*9 570	*7 850	6 670	4 510	4 510	3 070	3 170	2 000	*2 080	1 740	8.02
	Rear blade down (over rear)			*9 570	*8 910	*7 210	5 020	*5 250	3 450	*4 240	2 280	*2 080	2 000	
	Rear outrigger down (over rear)			*9 570	*9 570	*7 210	5 830	*5 250	3 990	*4 240	2 710	*2 080	*2 080	
	Front outrigger and rear blade down (over rear)			*9 570	*9 570	*7 210	7 040	*5 250	4 750	*4 240	3 380	*2 080	*2 080	
	Front blade and rear outrigger down (over rear)			*9 570	*9 570	*7 210	*7 170	*5 250	4 840	*4 240	3 460	*2 080	*2 080	
	4 outrigger down (over rear)			*9 570	*9 570	*7 210	*7 210	*5 250	*5 250	*4 240	3 990	*2 080	*2 080	
0 m (Ground)	Rear blade up (over front)	*8 340	*8 340	*11 270	7 970	*6 720	4 480	4 520	2 900	3 090	1 920	*2 280	1 770	7.82
	Rear blade down (over rear)	*8 340	*8 340	*11 270	9 050	*7 520	5 090	*5 460	3 280	*4 250	2 200	*2 280	2 040	
	Rear outrigger down (over rear)	*8 340	*8 340	*11 270	10 760	*7 520	5 890	*5 460	3 880	*4 250	2 640	*2 280	*2 280	
	Front outrigger and rear blade down (over rear)	*8 340	*8 340	*11 270	*11 270	*7 520	7 080	*5 460	4 820	*4 250	3 310	*2 280	*2 280	
	Front blade and rear outrigger down (over rear)	*8 340	*8 340	*11 270	*11 270	*7 520	7 210	*5 460	*4 920	*4 250	3 380	*2 280	*2 280	
	4 outrigger down (over rear)	*8 340	*8 340	*11 270	*11 270	*7 520	*7 520	*5 460	5 420	*4 250	3 920	*2 280	*2 280	
-1.5 m	Rear blade up (over front)	*13 490	*13 490	*12 170	7 630	6 960	4 290	4 340	2 710			*2 670	1 950	7.29
	Rear blade down (over rear)	*13 490	*13 490	*12 170	8 930	*7 640	4 910	*5 600	3 100			*2 670	2 240	
	Rear outrigger down (over rear)	*13 490	*13 490	*12 170	11 070	*7 640	5 890	*5 600	3 710			*2 670	*2 670	
	Front outrigger and rear blade down (over rear)	*13 490	*13 490	*12 170	*12 170	*7 640	7 280	*5 600	4 640			*2 670	*2 670	
	Front blade and rear outrigger down (over rear)	*13 490	*13 490	*12 170	*12 170	*7 640	*7 400	*5 600	4 760			*2 670	*2 670	
	4 outrigger down (over rear)	*13 490	*13 490	*12 170	*12 170	*7 640	*7 640	*5 600	5 520			*2 670	*2 670	
-3.0 m	Rear blade up (over front)	*21 490	*21 490	*12 680	7 590	6 690	4 060	4 240	2 600			*3 750	2 510	6.15
	Rear blade down (over rear)	*21 490	*21 490	*12 680	8 880	*7 780	4 660	*4 610	2 990			*3 750	2 880	
	Rear outrigger down (over rear)	*21 490	*21 490	*12 680	11 070	*7 780	5 630	*4 610	3 590			*3 750	3 470	
	Front outrigger and rear blade down (over rear)	*21 490	*21 490	*12 680	*12 680	*7 780	7 170	*4 610	4 530			*3 750	*3 750	
	Front blade and rear outrigger down (over rear)	*21 490	*21 490	*12 680	*12 680	*7 780	7 370	*4 610	*4 610			*3 750	*3 750	
	4 outrigger down (over rear)	*21 490	*21 490	*12 680	*12 680	*7 780	*7 780	*4 610	*4 610			*3 750	*3 750	

**ZAXIS 170W 2-PIECE BOOM, ARM 2.50 M,
3 800 KG COUNTERWEIGHT, WIDE GAUGE**

 Rating over-front or rear  Rating over-side or 360 degrees Unit : kg

Stabilization		Load radius										At max. reach		
		1.5 m		3.0 m		4.5 m		6.0 m		7.5 m				meter
														
7.5 m	Rear blade up (over front)					*4 260	*4 260					*2 440	*2 440	5.48
	Rear blade down (over rear)					*4 260	*4 260					*2 440	*2 440	
	Rear outrigger down (over rear)					*4 260	*4 260					*2 440	*2 440	
	Front outrigger and rear blade down (over rear)					*4 260	*4 260					*2 440	*2 440	
	Front blade and rear outrigger down (over rear)					*4 260	*4 260					*2 440	*2 440	
	4 outrigger down (over rear)					*4 260	*4 260					*2 440	*2 440	
6.0 m	Rear blade up (over front)					*4 350	*4 350	*4 070	3 400			*2 120	*2 120	6.76
	Rear blade down (over rear)					*4 350	*4 350	*4 070	3 810			*2 120	*2 120	
	Rear outrigger down (over rear)					*4 350	*4 350	*4 070	*4 070			*2 120	*2 120	
	Front outrigger and rear blade down (over rear)					*4 350	*4 350	*4 070	*4 070			*2 120	*2 120	
	Front blade and rear outrigger down (over rear)					*4 350	*4 350	*4 070	*4 070			*2 120	*2 120	
	4 outrigger down (over rear)					*4 350	*4 350	*4 070	*4 070			*2 120	*2 120	
4.5 m	Rear blade up (over front)			*6 550	*6 550	*5 090	5 080	*4 320	3 400	*2 160	*2 160	*2 000	*2 000	7.52
	Rear blade down (over rear)			*6 550	*6 550	*5 090	*5 090	*4 320	*3 780	*2 160	*2 160	*2 000	*2 000	
	Rear outrigger down (over rear)			*6 550	*6 550	*5 090	*5 090	*4 320	*4 200	*2 160	*2 160	*2 000	*2 000	
	Front outrigger and rear blade down (over rear)			*6 550	*6 550	*5 090	*5 090	*4 320	*4 320	*2 160	*2 160	*2 000	*2 000	
	Front blade and rear outrigger down (over rear)			*6 550	*6 550	*5 090	*5 090	*4 320	*4 320	*2 160	*2 160	*2 000	*2 000	
	4 outrigger down (over rear)			*6 550	*6 550	*5 090	*5 090	*4 320	*4 320	*2 160	*2 160	*2 000	*2 000	
3.0 m	Rear blade up (over front)			*7 610	*7 610	*6 240	*4 920	4 540	3 370	3 220	2 250	*1 990	*1 990	7.92
	Rear blade down (over rear)			*7 610	*7 610	*6 240	5 500	*4 790	3 730	*4 040	2 550	*1 990	*1 990	
	Rear outrigger down (over rear)			*7 610	*7 610	*6 240	6 140	*4 790	4 140	*4 040	2 890	*1 990	*1 990	
	Front outrigger and rear blade down (over rear)			*7 610	*7 610	*6 240	*6 240	*4 790	*4 790	*4 040	3 580	*1 990	*1 990	
	Front blade and rear outrigger down (over rear)			*7 610	*7 610	*6 240	*6 240	*4 790	*4 790	*4 040	3 640	*1 990	*1 990	
	4 outrigger down (over rear)			*7 610	*7 610	*6 240	*6 240	*4 790	*4 790	*4 040	4 040	*1 990	*1 990	
1.5 m	Rear blade up (over front)			*9 570	8 600	6 670	*4 870	4 510	3 330	3 170	2 200	*2 080	1 920	8.02
	Rear blade down (over rear)			*9 570	*9 570	*7 210	5 430	*5 250	3 750	*4 240	2 500	*2 080	*2 080	
	Rear outrigger down (over rear)			*9 570	*9 570	*7 210	6 070	*5 250	4 140	*4 240	2 840	*2 080	*2 080	
	Front outrigger and rear blade down (over rear)			*9 570	*9 570	*7 210	*7 210	*5 250	4 920	*4 240	3 530	*2 080	*2 080	
	Front blade and rear outrigger down (over rear)			*9 570	*9 570	*7 210	*7 210	*5 250	4 990	*4 240	3 590	*2 080	*2 080	
	4 outrigger down (over rear)			*9 570	*9 570	*7 210	*7 210	*5 250	*5 250	*4 240	3 990	*2 080	*2 080	
0 m (Ground)	Rear blade up (over front)	*8 340	*8 340	*11 270	8 720	*6 720	4 920	4 520	3 170	3 090	2 110	*2 280	1 960	7.82
	Rear blade down (over rear)	*8 340	*8 340	*11 270	9 910	*7 520	5 500	*5 460	3 590	*4 250	2 420	*2 280	2 250	
	Rear outrigger down (over rear)	*8 340	*8 340	*11 270	*11 260	*7 520	6 120	*5 460	4 060	*4 250	2 760	*2 280	*2 280	
	Front outrigger and rear blade down (over rear)	*8 340	*8 340	*11 270	*11 270	*7 520	7 320	*5 460	4 990	*4 250	3 450	*2 280	*2 280	
	Front blade and rear outrigger down (over rear)	*8 340	*8 340	*11 270	*11 270	*7 520	7 420	*5 460	*5 040	*4 250	3 510	*2 280	*2 280	
	4 outrigger down (over rear)	*8 340	*8 340	*11 270	*11 270	*7 520	*7 520	*5 460	5 420	*4 250	3 910	*2 280	*2 280	
-1.5 m	Rear blade up (over front)	*13 490	*13 490	*12 170	8 530	6 960	4 720	4 340	2 980			*2 670	2 150	7.29
	Rear blade down (over rear)	*13 490	*13 490	*12 170	10 030	*7 640	5 400	*5 600	3 410			*2 670	2 470	
	Rear outrigger down (over rear)	*13 490	*13 490	*12 170	*11 550	*7 640	6 180	*5 600	3 880			*2 670	*2 670	
	Front outrigger and rear blade down (over rear)	*13 490	*13 490	*12 170	*12 170	*7 640	*7 490	*5 600	4 850			*2 670	*2 670	
	Front blade and rear outrigger down (over rear)	*13 490	*13 490	*12 170	*12 170	*7 640	*7 570	*5 600	4 940			*2 670	*2 670	
	4 outrigger down (over rear)	*13 490	*13 490	*12 170	*12 170	*7 640	*7 640	*5 600	5 520			*2 670	*2 670	
-3.0 m	Rear blade up (over front)	*21 490	*21 490	*12 680	8 480	6 690	4 480	4 240	2 870			*3 750	2 770	6.15
	Rear blade down (over rear)	*21 490	*21 490	*12 680	9 980	*7 780	5 150	*4 610	3 290			*3 750	3 170	
	Rear outrigger down (over rear)	*21 490	*21 490	*12 680	11 770	*7 780	5 920	*4 610	3 770			*3 750	3 640	
	Front outrigger and rear blade down (over rear)	*21 490	*21 490	*12 680	*12 680	*7 780	7 530	*4 610	*4 610			*3 750	*3 750	
	Front blade and rear outrigger down (over rear)	*21 490	*21 490	*12 680	*12 680	*7 780	7 680	*4 610	*4 610			*3 750	*3 750	
	4 outrigger down (over rear)	*21 490	*21 490	*12 680	*12 680	*7 780	*7 780	*4 610	*4 610			*3 750	*3 750	

EQUIPMENT

● : Standard equipment

○ : Optional equipment

ENGINE

Aftertreatment device	●
Air cleaner double filters	●
Alternator 60 A	●
Auto idle system	●
Auto shut-down control	●
Cartridge-type engine oil filter	●
Cartridge-type fuel main filter	●
Cold fuel resistance valve	●
DEF/AdBlue® tank inlet strainer and extension filter	●
DEF/AdBlue® tank with ISO magnet adapter	●
Dry-type air filter with evacuator valve (with air filter restriction indicator)	●
Dust-proof indoor net	●
ECO/PWR mode control	●
Electrical fuel feed pump	●
Engine oil drain coupler	●
Expansion tank	●
Fan guard	●
Fuel cooler	●
Fuel pre-filter with water separator	●
Isolation-mounted engine	●
Maintenance free pre-cleaner	○
Radiator, oil cooler and intercooler	●

HYDRAULIC SYSTEM

Auto power lift	●
Control valve with main relief valve	●
Extra port for control valve	●
Full-flow filter	●
High mesh full flow filter with restriction indicator	○
Hose rupture valve for arm	●
Hose rupture valve for boom	●
Pilot filter	●
Power boost	●
Shockless valve in pilot circuit	●
Steering filter	●
Suction filter	●
Swing dampener valve	●
Variable reliefvalve for breaker & crusher	●
Work mode selector	●

CAB

All-weather sound suppressed steel cab	●
AM-FM radio	●
Ashtray	●
Auto control air conditioner	●
AUX function lever (Breaker assist)	●
AUX terminal and storage	●
Cigarette lighter 24 V	●
CRES V (Center pillar reinforced structure) cab	●
Drink holder with hot & cool function	●
Electric double horn	●
Engine shut-off switch	●
Equipped with reinforced, tinted (green color) glass windows	●
Evacuation hammer	●
Floor mat	●
Footrest	●
Front window washer	●
Hot & cool box	●
Intermittent windshield wipers	●
Key cylinder light	●
Laminated round glass window	○
LED room light with door courtesy	●
OPG top guard Level II (ISO10262) compliant cab	○
Pilot control shut-off lever	●
Power outlet 12 V	○
Rain guard	●
Rear tray	●
Retractable seat belt	●
ROPS (ISO12117-2) compliant cab	●
Rubber radio antenna	●
Seat : air suspension seat with heater	●
Seat adjustment part : backrest, armrest, height and angle, slide forward / back	●
Short wrist control levers	●
Sun visor	●
Transparent roof with slide curtain	●
Windows on front, upper, lower and left side can be opened	●
2 speakers	●
4 fluid-filled elastic mounts	●

MONITOR SYSTEM

Alarms: overheat, engine warning, engine oil pressure, alternator, minimum fuel level, hydraulic filter restriction, air filter restriction, work mode, overload, SCR system trouble, etc	●
Alarm buzzers: overheat, engine oil pressure, overload, SCR system trouble	●
Attachment operational information	●
Display of meters: Speedometer, Tachometer, Tripmeter, water temperature, hour, fuel rate, clock, DEF/AdBlue® rate	●
Other displays: work mode, auto-idle, glow, rearview monitor, operating conditions, etc	●
32 languages selection	●

LIGHTS

Additional boom light with cover	○
Additional cab roof front lights	○
Additional cab roof rear lights	○
Brake lamps	●
Clearance lamps	●
Hazard lamps	●
Licence lamp	○
Rotating lamp	○
Turn signal lamps	●
Working lights	●
2 head lights	●

UPPER STRUCTURE

Batteries 2 x 93 Ah	●
Battery disconnect switch	●
Body top handrail	●
Counterweight 3 400 kg	●
Counterweight 3 800 kg	○
Electric fuel refilling pump with auto stop and filter	●
Fuel level float	●
Handrail (cab top)	●
Handrail (platform)	●
Hydraulic oil level gauge	●
Rear view camera	●
Rear view mirror (right & left side)	●
Side view camera	○
Skid-resistant plates and handrails	●
Swing parking brake	●
Undercover	●

UNDERCARRIAGE

Clamshell bracket	○
Front cover	○
Front dozer blade + rear outrigger	○
Front outrigger + rear dozer blade	○
Front outrigger + rear outrigger	○
Parking brake	●
Rear dozer blade	○
Rear outrigger	○
Right toolbox	○
Toolbox: left chassis	●
Traction types pattern tires (10.00-20 14PR)	●
Tire spacer	●
Wide gauge axle	○
4 tie down brackets	●

FRONT ATTACHMENTS

Casted bucket link A	●
Centralized lubrication system	●
Dirt seal on all bucket pins	●
Flanged pin	●
HN bushing	●
Reinforced link B	○
Reinforced resin thrust plate	●
WC (tungsten-carbide) thermal spraying	●
Welded bucket link A	○

ATTACHMENTS

Accessories for 2 speed selector	○
Additional pump (30 L/min)	○
Assist piping	○
Attachment basic piping	●
Breaker and crusher piping	●
Clamshell piping	○
HSB Parts for breaker and crusher	●
Pilot accumulator	●
PTO valve	○

MISCELLANEOUS

Global e-Service	●
Lockable fuel refilling cap	●
Lockable machine covers	●
Onboard information controller	●
Standard tool kit	●
Travel direction mark on chassis frame	●

Standard and optional equipment may vary by country, so please consult your Hitachi dealer for details.

Prior to operating this machine, including satellite communication system, in a country other than a country of its intended use, it may be necessary to make modifications to it so that it complies with the local regulatory standards (including safety standards) and legal requirements of that particular country. Please do not export or operate this machine outside the country of its intended use until such compliance has been confirmed. Please contact your Hitachi dealer in case of questions about compliance.

These specifications are subject to change without notice. Illustrations and photos show the standard models, and may or may not include optional equipment, accessories, and all standard equipment with some differences in color and features. Before use, read and understand the Operator's Manual for proper operation.

